



Merri Health

Occupational Therapy Guidelines for the Prescription of Bidet Equipment

Merri Health (2021)

ACKNOWLEDGEMENTS

Merri Health Coburg would like to thank La Trobe University Master of Occupational Therapy Practice students Amira Alameddine, Constance Liberty Vari and Tiffany Sze Wan Chan, for their contribution to the development of this resource as part of the ten-week final year project placement, Macro Strategies for Advanced Professional Practice.

Special thanks are extended to the project sponsors Craig Jackman and Lauren Hennessy for their time, expertise, guidance and ongoing support throughout the duration of the project.

We would also like to acknowledge the Independent Living Team and the NDIS service team at Merri Health Coburg for their advice and input on the development of this resource.

EXECUTIVE SUMMARY

At present there is minimal research and guidelines on the topic of bidet use and installation in Australia. The intention of this document is to provide clarity, evidence and guidance to Occupational Therapists (OTs) prescribing bidets to adults and older adults. This resource also addresses adults within the bariatric range. This document first provides a summary of the gathered research on the benefits, indications and contraindications of bidet use, as well as the relevant Victorian plumbing, building and electrical compliance requirements. Following this, a flow chart has been developed, to guide Occupational Therapists through the process of assessing for and prescribing bidet equipment. Each section of this flow chart is associated with the sections in the document. Visual diagrams have been incorporated into this resource to supplement the written information, improving understanding and clarity of key concepts.

Section One: Assessment of the Client

The assessment of the client section provides considerations that can be utilised to support the assessment of adult clients in both non-bariatric and within the bariatric range regarding bidet prescription.

Section Two: Assessment of the Home Environment

The assessment of a client's home is an important component of determining the compatibility and associated costs of bidet installation including plumbing, building or electrical requirements. This section is intended to empower OTs with the resources and information to effectively collaborate with supplier and installer companies when recommending bidet equipment. A *"Occupational Therapy Information Gathering Checklist"* (see Appendix B) has been developed to support information gathering when assessing a client's home prior to obtaining a quote for a suitable bidet.

Section Three: Client Education

When first discussing the need for bidet equipment with a client and/or their family, Occupational Therapists can provide clear information and resources to aid their clients in the decision-making process. This section provides information to support client education regarding types of bidet equipment, maintenance and installation requirements. The *"Educational Client Handout"* (see Appendix C) can be used as a written resource to supplement this verbal education.

Section Four: Funding, Bidet products, Suppliers and Installers

These sections are intended to make it accessible for Occupational Therapists to obtain information regarding supplier and installer companies, funding bodies and bidet product information. This may streamline the process of researching information to source and install a bidet including key contact details, product specifications, warranty information, product costs and funding avenues. Please note that information was accurate at the time the document was produced and all information should be confirmed.

Contents

INTRODUCTION	1
Terminology	2
Abbreviations	4
BENEFITS, INDICATORS AND CONTRAINDICATIONS TO CONSIDER	5
Benefits of bidet use	5
Indicators of bidet use	5
Contraindications of bidet use.....	6
INSTALLATION REQUIREMENTS - VICTORIA	6
Registered Air Gaps (RAG)	7
Backflow Prevention and Reduced Pressure Zone Devices (RPZD)	7
Electrical outlets.....	9
BIDET PRESCRIPTION FLOW CHART	10
ASSESSMENT OF THE CLIENT	11
Initial Assessment	11
Functional Assessment/Task Analysis.....	11
Further considerations for clients of short stature	12
Further considerations for clients within the bariatric range	12
Potential Configuration Strategies for Clients Within the Bariatric Range	13
Weight Ascertainment	13
The Bedside Method (Buckley et al., 2011):.....	14
Key Body Measurements and Anthropometrics	14
Body Measurements of Clients Within the Bariatric Range:	15
Compatibility of Assistive Equipment with Bidet/Douche Toilet Seats.....	16
Table 3: Compatible commode supplier information.....	17
Figure 2: Working examples of ETAC Swift Mobile 2 commode situated over a compatible bidet toilet seat.....	18
ASSESSMENT OF THE HOME ENVIRONMENT	19
Toilet Suite Types and Pan Shapes	19
Toilet Measurements.....	20
Table 7: Toilet pan measurement guide.....	21
Bidet Installation Requirements	22
Bathroom and Environmental Assessment	23
CLIENT EDUCATION	25

FUNDING OPTIONS	25
Table 8: Bidet funding information.....	26
Table 9: National funding bodies.....	30
PRODUCT LISTS	31
Table 12: Additional maintenance parts for bidets	36
Standalone bidettes:.....	Error! Bookmark not defined.
SUPPLIER AND INSTALLER LISTS	37
Disclaimer.....	43
REFERENCES	44
APPENDICES	48
Appendix A - Key Stakeholders Consulted	48
Appendix B - Bidet Information Gathering Checklist.....	50

INTRODUCTION

To date, there is a limited amount of research, clinical guidelines and comprehensive resources that explore the topic of bidets as an assistive technology for clients in a community health setting.

This resource was created with the intention of bridging this knowledge gap and providing a collated resource to assist Occupational Therapists throughout the prescription process of bidet products for adult clients, both non-bariatric and within the bariatric range.

The information in this resource has been compiled utilising evidence-based research as well as the expertise and feedback of key stakeholders (*see Appendix A*) including community Occupational Therapists (across VIC, WA, NSW & ACT), industry partners including Victorian plumbing and building authorities, equipment suppliers, installers, manufacturers, and key funding bodies. Key parts of this resource have been informed by verbal communications with these stakeholders. Information regarding the Australian standards was compiled during a period when the standards were being updated. The most up-to-date information was gathered verbally from the Victorian Building Authority and the Victorian Master Plumbers Association.

A short survey of open-ended questions was developed and distributed to two online group platforms, in which various community Occupational Therapists across Australia are members of. The aim of the survey was to determine the perceived gaps in knowledge and challenges in bidet prescription amongst Occupational Therapists practicing in Australia. This information was used to structure and focus the information in this document.

Terminology

There is variability in the terminology used to refer to bidet products. For the purpose of providing clarity and consistency, the following terminology was used in this document:

<p>Handheld bidet: This refers to a hose that connects to a toilet's water supply. Handheld bidets may also be referred to as hand sprays or flexible hoses.</p>	
<p>Bidet/douche toilet seat: This refers to a seat that has an inbuilt water outlet situated below the rim of the seat and replaces an existing toilet seat. Bidet/douche toilet seats may also be referred to as bidet toilet seat, douche toilet seat, electronic bidet, electric bidet toilet seat, or smart bidet seats.</p>	
<p>Bidet attachment: This refers to a bidet product that fixes around an existing toilet seat (i.e. does not replace the toilet seat) and is controlled using the console fitted to the side of the attachment. The toilet seat must be removed to install and the reinstated. These types of bidet are also known as non-electric bidets. They generally spray cold water, unless can be connected to a hot water tap. They also don't have features of an electric bidet seat e.g. a warm air dryer.</p>	

Figure 1. evekare White Bidet Spray (Bunnings website)

Figure 2. Coway BA 15E Bidet (The Bidet Shop)

Figure 3. LUELUE LB1000. (Luelue Bidet)

Standalone bidette:

This refers to a traditional, European style bidet that is separate to the toilet suite. This is a type of standalone bidette that has the water tap situated over the rim of the pan. These require the user to squat or sit over the bidet either forward facing or backwards facing. Therefore, this requires an adequate level of functional mobility, balance and strength.



Figure 4. Caroma Cube Bidette. (Bentons)

Bidet toilet/shower toilet:

This refers to a toilet with inbuilt bidet functions. This type has a water outlet situated below the rim of the pan.



Figure 5. eberit Aquaclean Sela Wall Hung Shower Toilet – 146220211. (UKbathrooms)

Bariatric: There is variability in the way that this is defined as some research utilises weight in kilograms, body mass index (BMI) or circumferential body measurements to categorise a person as bariatric. For the purposes of consistency in this document, ‘bariatric’ refers to any individual who has a BMI greater than or equal to 40. This is in line with definitions by the World Health Organization (2003) and the Australian Department of Health and Ageing (2010), National Health and Medical Research Council (2013). ‘Obese’, ‘morbidly obese’ and ‘class III obesity’ are often used as synonyms for ‘Bariatric’ within many research papers. Throughout this document, individuals who fall into this category are referred to as ‘clients within the bariatric range’, to ensure that language is weight sensitive (Department of Health and Human Services, 2017).

Abbreviations

ABCB - Australian Building Codes Board

BMI - Body Mass Index

CAPS - Continence Aids Program

CHSP - Commonwealth Home Support Program

COG - Centre of Gravity

DVA - Department of Veteran Affairs

GP – General Practitioner

HCP - Home Care Package

MAC - My Aged Care

NCC - National Construction Code

NDIS - National Disability Insurance Scheme

OT - Occupational Therapist

PCA - Plumbing Codes Australia

PIP - Personal Independence Providers

RAG - Registered Air Gap

RCD - Residual Current Device

ROM - Range of Movement

RPZD - Reduced Pressure Zone Device

SWEP - State-Wide Equipment Program

SWL - Safe Working Load

TAC - Transport Accident Commission

BENEFITS, INDICATORS AND CONTRAINDICATIONS TO CONSIDER

Benefits of bidet use:

For a client:

- Can improve dignity and privacy (Gresham, 2018)
- Can increase client independence in attending to personal hygiene by minimising the level of assistance carers provide in toileting (de Lange et al., 2018)
- May reduce incontinence through prompting a more complete void of bowel and bladder (Gresham, 2018)
- May minimise the cost spent on continence products by reducing dependence on incontinence aids (Gresham, 2018).
- Can assist to reduce incidences of UTIs that can be acquired through faecal contamination in cognitively impaired clients (Gresham, 2018)
- Can assist in therapeutic management of some diseases including anal eczema (Gresham, 2018; Havlickova & Weyandt, 2014)

For a carer:

- May reduce the risk of manual handling injuries associated with awkward posturing when providing toileting assistance (de Lange et al., 2018; Gresham, 2018)
- May decrease the amount of personal care assistance required to be provided to clients (Gresham, 2018)

Indicators of bidet use:

- Clients who are unable to independently wipe themselves following toilet use due to limited upper limb function as a result of reduced range of movement (ROM), muscle weakness and/or amputations. This includes clients with both chronic and neurodegenerative conditions. Due to the impact of these conditions on upper limb function, clients could greatly benefit from a bidet to supplement wiping (Bassola & Lusignani, 2017; Msengana et al., 2019; Vansteenkiste et al., 2017).
- Clients whose sensory or visual impairment reduces their ability to maintain personal hygiene tasks i.e. wiping independently, could benefit from a bidet to supplement wiping (Gresham, 2018).
- Clients who do not receive any/enough funding for personal care assistance, or when providing toileting assistance to clients is placing strain on carers.
- Clients who have excess adipose tissue preventing them from reaching their perineal area may benefit from a bidet that offers wash and/or dry features.
- Clients with restricted spinal rotation.
- Clients with ongoing faecal incontinence.
- Clients with reduced standing balance.
- Clients with neurological conditions causing reduced hand function or impaired spinal extension when standing

Contraindications of bidet use:

- Clients weighing over 200kg. There are currently no bidets sold within Australia (that comply with Australian standards) with safe working limits over 200kg. Consider suitability of a mobile shower commode with a greater SWL e.g. the ETAC SWIFT MOBILE 2 XL (250kg).
- May not be suitable for use with pregnant clients, as chronic use of bidet is associated with a higher rate of abnormal vaginal colonisation by gram negative bacteria, as well as preterm birth in higher risk pregnancies (Kim et al., 2019).
- Some evidence posits that bidet/douche toilet seats without a self-cleaning mechanism increase the risk of a water nozzle becoming contaminated with bacteria such as staphylococcus aureus, when shared with multiple users. This may place an individual at risk of a cross infection if sharing with multiple users (Kanayama Katsuse et al., 2017; Tsunoda et al., 2019).
- Consider reliance on bidet use and impact on anxieties around toileting outside the home and potential social isolation.

INSTALLATION REQUIREMENTS - VICTORIA

Due to the risk of backflow of contaminated water into the water main (drinking) supply, there are strict compliance standards and requirements for the installation of bidet products. This section provides a summary of requirements that an Occupational Therapist should be aware of when prescribing/making recommendations for products based on a client's functional need. There is also reference to the relevant standards that manufacturers and certified plumbers must comply with when manufacturing or installing such items, and an explanation of registered air gaps (RAG), Backflow Prevention and Reduced Pressure Zone Devices (RPZD) and watermarking.

The requirements to make a bidet compliant with the Plumbing Code of Australia varies across states and territories. The information in this document relates to Victoria and is subject to change. Other relevant and state territories should be contacted for further clarity (listed below):

Currently to comply with the standards in Victoria:

- Handheld bidet sprays always require an RPZD.
- Standalone bidettes with a registered air gap do not require an RPZD (*see Figure 6*).
- All bidet/douche seats/bidet attachments need to have a Watermark logo to be compliant (example below).
 - If the Watermark logo indicates certification is under Watermark WMTS-051 (**2016**), an **RPZD is not required**, as these should include a dual check valve.
 - If the Watermark logo indicates certification is under Watermark WMTS-051 (**2020**), installation of an **RPZD is required**.

Note: As of July 2021, the VBA has advised that the Australian Building Codes Board (ABCB) are currently reviewing the watermarking standards and these requirements are likely to change in the future.

It is recommended that the Occupational Therapist ask the supplier if the item quoted for is watermarked and under which year (e.g. WMTS-051: 2016 or WMTS-051: 2020) in order to determine if an RPZD is required to be included in the quotation/scope of works.

Registered Air Gaps (RAG)

In accordance with AS 1172.3, a RAG is a minimum 25 mm gap between the bottom of a bidette's water outlet and the top of the overflow level of the pan (Standards Australia, 2010b). If this RAG is not present, a 'high hazard' backflow prevention device such as an RPZD must be installed.

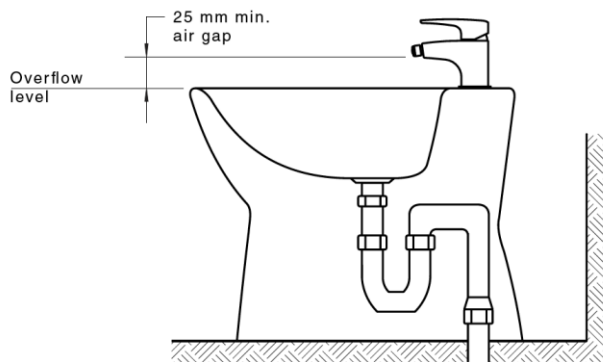

Figure 6. Example of a standalone bidette with an over-the-rim fixture that has a 25mm RAG. This does not require a high hazard backflow prevention device (Standards Australia, 2010b)



Figure 7. Example of a bidet/douche toilet seat fixed to a toilet pan, with a below-the-rim fixture. This does not have a 25mm RAG. This may require a high hazard backflow prevention device, depending on its Watermark certification.

Backflow Prevention and Reduced Pressure Zone Devices (RPZD)





Backflow prevention devices prevent the mixing of contaminated water with the drinking water of a dwelling's plumbing system (ABCB, 2019). An RPZD or an RPZ valve is a backflow prevention device installed by a certified plumber where a high hazard fixture (e.g. handheld bidet) is in situ. RPZDs are a requirement for some types of bidet fixtures to prevent water contamination. RPZDs have installation compliance requirements and not all properties are set up to meet these requirements e.g. if the toilet does not back onto an outside wall.

Note: *If a backflow prevention device such as an RPZD is not installed, this could result in the backflow of contaminated water into water mains. This is a **public health matter** that has **serious ramifications** for the health of the community.*

Note: *Toilet seat spacers/raisers that are used to raise the height of the bidet toilet seat, do **NOT** replace the need for an RPZD (Standards Australia, 2021b).*

Compliance with electrical and plumbing standards can be identified through the following certification logos:

Table 1: Australian plumbing and electrical compliance logos

 <p style="text-align: center;">OR</p> 		
<p style="text-align: center;">WaterMark Certification Logo (Plumbing)</p>	<p style="text-align: center;">C-Tick Logo (Electrical)</p>	<p style="text-align: center;">Regulatory Compliance Mark (Electrical)</p>

The WaterMark logo is usually supplemented with the standard number and certificate number beneath it. The standard number year (e.g. WMTS-051: 2016 or WMTS-051: 2020) will inform the need for an RPZD (see below). If a supplier or manufacturer’s website does not clearly provide this information regarding the certification of their bidet products, it is recommended that they are contacted to clarify this.

The installation requirements are current at the time the document was composed, however if there is any doubt regarding the need to install an RPZD, relevant and state territories can be contacted for further clarity (listed below):

VIC:

Victorian Building Authority:

PH: 1300 815 127

E: plumbingtechnicaladvice@vba.vic.gov.au.

ACT:

Access Canberra

PH: 6207 6907 or 6207 6261

NSW:

NSW Gov Fair Trading Building Code Advisory Service

PH: (02) 9372 9271

NT:

Northern Territory Consumer Affairs

PH: (08) 8999 1999 or 1800 019 319

E: consumer@nt.gov.au

QLD:

Queensland Building and Construction Commission

PH: 139 333

General enquiry form: <https://my.gbcc.qld.gov.au/s/contactsupport>

SA:

Consumer and Business Services South Australia

PH: 131 882

General enquiry form:

<https://forms.sa.gov.au/#/form/5e8a72c4ad9c5922f01d430e/app/611a05574d433148646c119d>

TAS:

Consumer, Building and Operational Services

PH: 1300 654 499

E: CBOS.info@justice.tas.gov.au

WA:

Building and Energy Western Australia

PH: 1300 489 099

E: be.info@dmirs.wa.gov.au

For additional information regarding the watermark standards please contact:

ABCB

PH: 1300 134 631

Website: www.abcb.gov.au

Electrical outlets

For electric bidet seats, a power point will need to be available within approximately 1.5 metres from the toilet. If this is not already present, a certified electrician will need to install an electrical outlet in accordance with AS/NZS 3000 (2018) Amd no.2 (2021) which may increase installation costs.

BIDET PRESCRIPTION FLOW CHART



Following full client assessment and funding determination, proceed with the steps below:

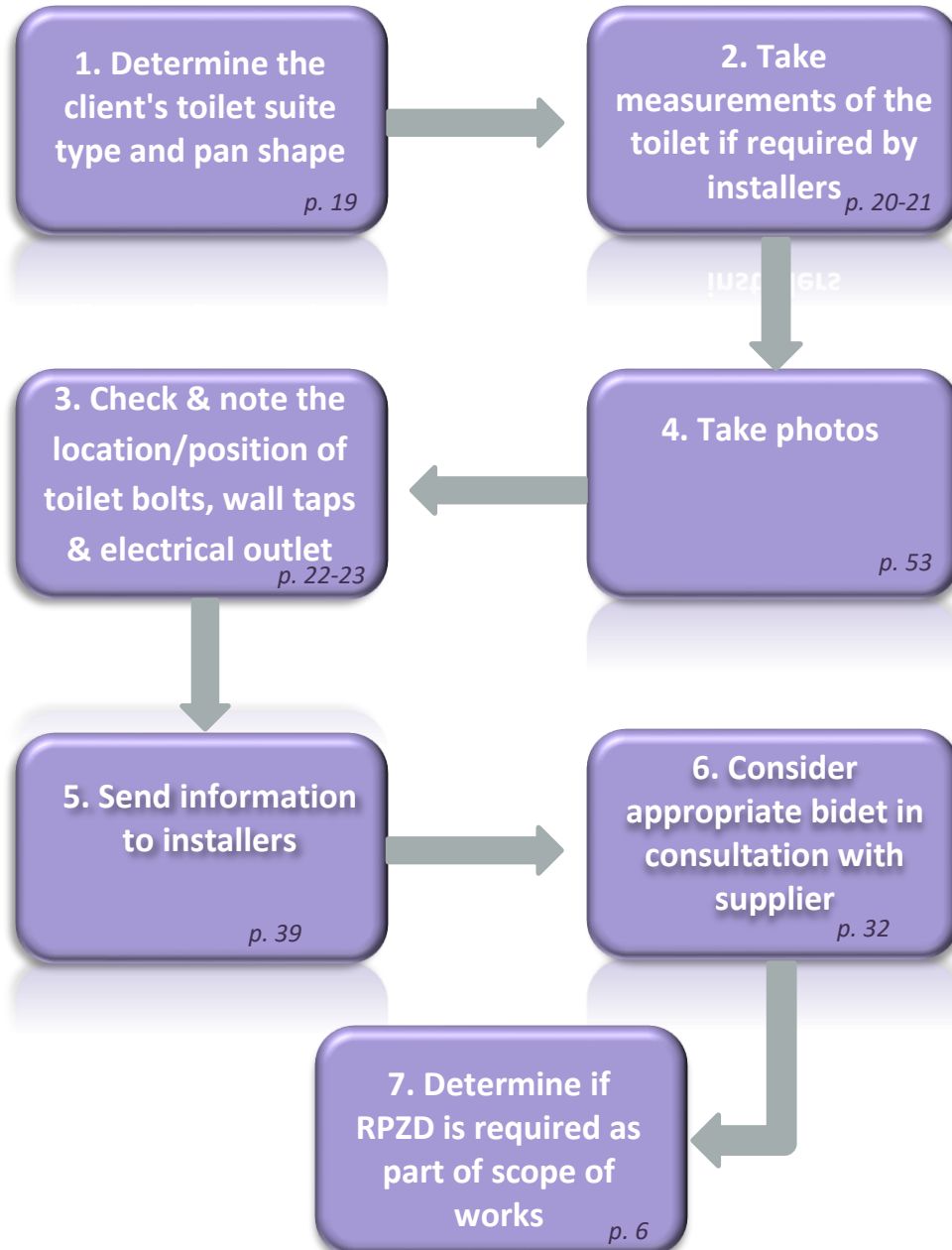

ASSESSMENT OF THE CLIENT

Initial Assessment

Complete an initial assessment to gather the following client information:

- Current diagnosis, comorbidities, and medical history
- Client's anthropometrics including weight and any fluctuation patterns
- Social history/situation – other home occupants, carer supports, services used and frequency, funding requirements
- Cultural considerations – cultural norms, cultural identity, beliefs and practices
- General home environment information - dwelling type, home ownership status etc.
- Premorbid function and level of assistance required in activities of daily living
- Skin integrity and pressure care assessment
- Cognition – alertness, orientation, sequencing, planning, memory, praxis, executive function etc.
- Occupational performance issues and occupation-based goals

Functional Assessment/Task Analysis

A functional assessment will help clinicians understand the specific occupational performance or environmental barriers that may be limiting independence with toileting (Wales et al., 2016). The way individuals complete the toileting process may differ from person to person, and this will impact on how they use a bidet/douche toilet seat or bidet attachment (Wilson & Landry, 2014). A task analysis can be completed to provide a breakdown of each step in the toileting process to reflect the manner and sequence in which a client performs each step (Wilson & Landry, 2014).

- Observe the client completing the task in their home or similar environment
- Determine and document manual handling requirements/level of assistance client needs
- Identify performance skills e.g. for independent use, consider the following:
 - Functional reach and range of movement – *can the client reach for and use remote control if required?*
 - Trunk stability and postural challenges – *bidet/douche seats are fixed by screws. If the client has poor postural control, causing them to 'flop' onto the seat, this may cause damage/loosening of the seat and may increase risk of injury and falls.*
 - Static and dynamic balance – *bidet/douche seats between 30-80mm above toilet pan and are fixed by two screws, which may impact ability to reach the floor and impact their base of support, leading to instability.*
 - Muscle strength and transfer patterns – *may impact on safe transfers on and off a toilet e.g. good upper limb and lower limb strength is required to gradually lower oneself onto a bidet, reducing the force placed upon the product.*
 - Fine and gross motor skills, as well as grip strength in upper limbs and hands – *to use remote control if required*
- Assess falls risk and consider control measures regarding bidet use i.e. grab rail installation, appropriate footwear, gait aids

- Assess the appropriateness of the seat height to the client – this will likely impact trunk stability, sitting balance, safe transfers and functional reach capacity. Indications that the seat height is too high include feet not flat on the ground (shorter clients), knees higher than hips (taller clients) or not being able to sit back sufficiently onto the seat.
- Need for use of gait aid/commodes – will help determine circulation space requirements and the potential need for additional grab rails or transfer equipment.

Further considerations for clients of short stature

The addition of a bidet/douche toilet seat can raise the toilet height by approximately 30mm. Depending on the height of the existing toilet, this can result in a total seat height of 430mm or 470mm and is likely to impact on safe transfers for shorter clients. If their feet cannot reach the ground sufficiently, base of support, propulsion, balance, safety and independence with transfers may be impacted. In addition, falls risk may increase. For clients with continence issues, inappropriate toilet seat height may compromise optimum positioning for continence which recommends knee placement to be slightly higher than the hips (Queensland Health, 2019).

Potential solutions:

- Use of a foot stool placed beneath the client's feet whilst seated to aid their base of support, seated stability and promote optimum positioning for continence (Queensland Health, 2019). *Note: Determine the client's ability to safely move the stool prior to transferring as foot stools can be a trip hazard and falls risk.*
- Use of grabrails to make the transfer process on and off the toilet safer.
- Handheld bidets can be an alternative to a bidet/douche toilet seat, as they do not raise the toilet height. *Note: The use of handheld bidets requires adequate fine motor control, flexibility and ROM in the upper limbs and RPZD installation.*
- An existing toilet may need to be replaced with one of a lower height to accommodate clients of short stature who are using a bidet/douche toilet seat. A standard toilet typically has a height of 400mm (Standards Australia, 2021c). Generally, toilets under 400mm are considered to be a children's toilet in Australia and therefore may be referred to under this name.

Further considerations for clients within the bariatric range

- *Reduced ROM* - Functional reach and spinal rotation may be reduced due to increased body mass i.e., heavy upper and lower limbs.
- *Altered centre of gravity (COG)* - COG sits more anteriorly in overweight/obese clients, and this may impact on their transfer patterns as well as static and dynamic balance.
- *Body shape* - This is likely to impact what areas of excess body tissue (e.g. panniculus) may hang over a toilet seat/bidet. Body shape might also impact a client's COG, trunk stability and functional reach. If a 'shelf' is present, this may impact the positioning and reach of the spray function to the required area.

- *Gluteal shelf/bulbous gluteal region (see anthropometrics section)* - This is extra adipose tissue deposited around the lower back and gluteal region, which may indicate increased space requirements at the back of a toilet seat.

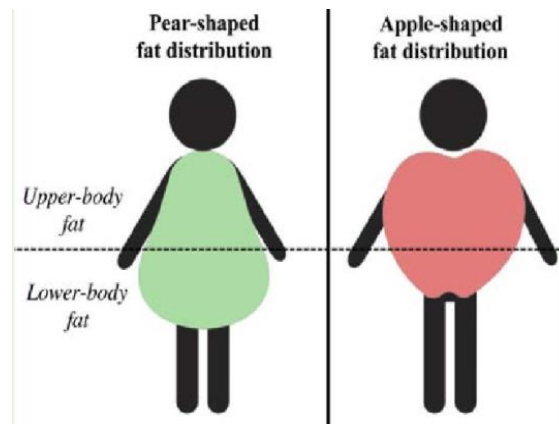

Figure 7: Body shapes based on typical body fat distribution for individuals within the bariatric range (Feijoo-Bandin et al., 2016).

Potential Configuration Strategies for Clients Within the Bariatric Range

- Bidet/douche toilet seats with detachable lids and/or an elongated bidet/douche toilet seat may accommodate extra space for a gluteal shelf (see Table 10). **Note:** *An elongated bidet seat will likely require replacement of the entire toilet suite to ensure the toilet dimensions match the bidet seat dimensions so as not to impact stability.*
- Most bidet toilet seat controls are mounted as an attachment to the left or right of the seat. Wall mounting of the wireless remote should be considered in cases where excess body tissue impedes access to the controls. **Note:** *Wall mounting remotes may not be feasible for some types of bidet/douche toilet seats.*

Weight Ascertainment

Obtaining a client's true weight is a key consideration in the prescription of any equipment within the community setting. When considering clients within the bariatric range, accurate weight ascertainment is important in ensuring the client is safe and is not exceeding SWL on prescribed equipment. Many manufacturers recommend safe product use is best achieved by staying 10-15 kg under a product's SWL. This could provide leeway for weight fluctuation, particularly in these clients.

Note: *Under the AHPRA & National Boards regulatory guide 2021, clinicians who engage in inappropriate prescription practices and/or treatment decisions that are not clinically justified or evidence based, will incur **full liability and potential legal ramifications** (AHPRA, 2021). This includes prescription of equipment with inadequate SWL, as this can significantly increase a client's risk of falls and therefore potential injury.*

Ascertaining accurate client weight, particularly when a client is within the bariatric range, can present some challenges. The following listed methods should be considered from most to least accurate:

1. Clients may be able to receive a GP referral to a hospital outpatient or bariatric clinic that offers bariatric weighing services. The Alfred Hospital in Victoria offers this through their bariatric clinic. **Note:** *There are usually lengthy waitlists for clinic appointments.* Occupational Therapists can advocate to a client's GP regarding the need for a referral.
2. Refer to/request access to recent client medical records from a client's GP, recent hospital admission, dietician etc. detailing current weight and weight history.
3. Ask the client to estimate their own weight as accurately as they can. **Note:** *This should be taken as a conservative estimate.*
4. In circumstances where the above methods are not viable due to client reliability (mental health issues, cognitive concerns, language barriers etc.), the 'bedside method' can be used to ascertain a conservative estimate of a client's weight.

The Bedside Method (Buckley et al., 2011):

This is a standardised method of estimating weight in clients. Abdominal circumference should be taken horizontally across the line of the client's belly button. Thigh circumference should be taken 10 cm above the knee joint.

Note: *Any weight determined through this method should be taken as a **conservative estimate**. This method is less accurate in ascertaining female weight than male weight and should be used cautiously.*

** Input relevant values into the formulas below**

Estimation Formula:

Male Actual Body Weight = $-47.8 + 0.78 (\text{abdominal circumference}) + 1.06 (\text{thigh circumference})$

Female Actual Body Weight = $-40.2 + 0.47 (\text{abdominal circumference}) + 1.30 (\text{thigh circumference})$

Key Body Measurements and Anthropometrics

In order to determine the best fit bidet seating for a client, it is important to obtain accurate and relevant anthropometric measurements and dimensions (Padilla, Ferreyro & Arnold, 2021). An upper/lower limb assessment can be completed to determine a client's functional reach, ROM, stability, transfer patterns and standing/sitting height when considering the prescription of a bidet.

Body Measurements of Clients Within the Bariatric Range:

In addition to the previously mentioned assessments, the following specific body measurements may be required for bidet prescription of clients within the bariatric range.

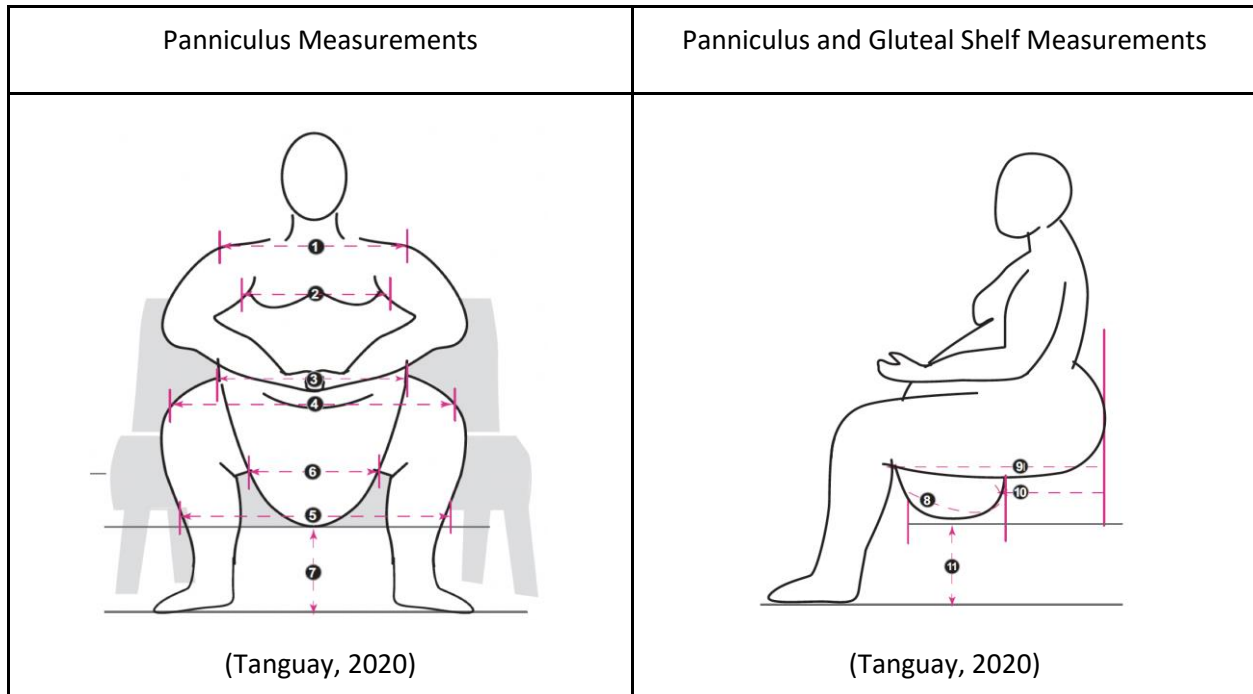

Figure 8: Panniculus and gluteal shelf measurements

Key Anthropometric Considerations:

- Most important measurements for bidet prescription include: **popliteal crease to posterior gluteal shelf (thigh length) (9)**, **overall seated hip width (3)**, **seated lateral knee to lateral knee width (4)**.
- Lateral elbow to lateral elbow width may be required if prescribing bilateral handrails with a bidet/douche toilet seat.
- Clients presenting with a large panniculus may require measurements such as **pannus width (6)**, **pannus depth (8)** and **pannus to floor (7)** to be completed to determine if any obstruction of the bidet may occur following installation. Consider risks to skin integrity also caused by shear.
- The height between the floor and the client's popliteal crease (behind knee) can inform the need for a spacer/raiser to achieve optimum transfer height.

Note: Consider a client's height and anthropometric measurements when prescribing a toilet seat spacer/raiser as this may increase their risk of falls and possible injury (Australian Commission on Safety and Quality in Healthcare, 2005).

Compatibility of Assistive Equipment with Bidet/Douche Toilet Seats

Table 2: Assistive technology compatibility

Toilet seat raiser/spacer	Only specific toilet seat raisers are compatible with all bidet toilet seats. Compatible toilet seat raisers are listed in <i>Table 11</i> .
Mobile shower commode	<p>Compatibility can be limited due to the product dimensions. Mobile shower commode seat heights are often too low to effectively go over the bidet seat (height of 430mm or 470mm).</p> <p>The sensor feature on some bidet/douche toilet seats. One compatible option is the ETAC Swift Mobile 2 range of commodes (<i>see Table 3</i>). These are mostly compatible with COWAY BA08 bidet seats (see Figure 9 for a working example). In this case, the side remote control will have to be unscrewed (possibly wall mounted) to enable room for the commode to sit back far enough. Pressure sensors on the bidet toilet seat may be able to be deactivated to allow use of the commode (consult supplier/manufacturer for details). Installing a sensor bypass switch may be an option, however this may affect the warranty.</p> <p>Note: <i>If the seat sensor is deactivated, some features may not be able to be controlled e.g. night light on/off, silent mode on/off, and nozzle cleaning.</i></p>
Over toilet frame/aid	Over toilet frames may be compatible if height adjustability is great enough to accommodate the total toilet height (with bidet/douche toilet seat attached). However, the control may need to be moved to a wall mounted option.
Toilet surround/bariatric support frame	This equipment is likely to be compatible as long as the product is able to fit around the toilet suite.

See Table 11 (p 34) for additional bidet seat accessories and attachments.

Table 3: Compatible commode supplier information



Supplier information	Product & Approx. Cost	SWL	Features		
<p>Patient Handling Ph: 1300 734 862 W: https://www.patienthandling.com.au/</p> <p>Shipping: Australia wide</p> <p><i>Note: Product does not arrive assembled</i></p>	<p>ETAC SWIFT MOBILE 2</p>  <p>(ETAC, 2021) Cost: \$1,280 approx. (not including shipping/delivery)</p>	<p>160kg</p>	<ul style="list-style-type: none"> • Height adjustable seat: 450mm – 600mm • Adjustable width and height of arm rests (+/- 6cm in either direction) • Swing away footrests are height adjustable & are offered in shorter version for clients of short stature • Rear cut-out seat 		
<p>Patient Handling Ph: 1300 734 862 W: https://www.patienthandling.com.au/</p> <p>Shipping: Australia wide</p> <p><i>Note: Product does not arrive assembled</i></p>	<p>ETAC SWIFT MOBILE 2 XL</p>  <p>(ETAC, 2021) Cost: \$1,600 approx (not including shipping/delivery)</p>	<p>250kg</p>	<ul style="list-style-type: none"> • Wider frame to accommodate individuals within the bariatric range • Height adjustable seat: 450mm – 600mm • Adjustable width and height of arm rests (+/- 6cm in either direction) • Swing away footrests are height adjustable & are offered in a shorter version 		
<p>In the event that the above commodes are deemed not appropriate for a client, a customised commode designed to be compatible with a bidet/douche toilet seat is an alternative option. Raz Design commodes offer this, and costs range approximately between \$6k-10k at the time of developing this document (July 2021). See Raz supplier information below.</p> <p>Contact details:</p> <table border="0" style="width: 100%;"> <tr> <td style="width: 50%;"> <p>Active rehabilitation equipment (Bendigo, VIC) Ph: 03 5441 8966 W: https://www.activerehab.net.au/</p> </td> <td style="width: 50%;"> <p>Fisher Lane Mobility (Abbotsford, VIC) Ph: 03 9419 2250 W: http://www.fisherlane.com.au</p> </td> </tr> </table>				<p>Active rehabilitation equipment (Bendigo, VIC) Ph: 03 5441 8966 W: https://www.activerehab.net.au/</p>	<p>Fisher Lane Mobility (Abbotsford, VIC) Ph: 03 9419 2250 W: http://www.fisherlane.com.au</p>
<p>Active rehabilitation equipment (Bendigo, VIC) Ph: 03 5441 8966 W: https://www.activerehab.net.au/</p>	<p>Fisher Lane Mobility (Abbotsford, VIC) Ph: 03 9419 2250 W: http://www.fisherlane.com.au</p>				



Figure 9: Working examples of ETAC Swift Mobile 2 commode situated over a compatible bidet toilet seat (photos courtesy of Calvary Health Care Occupational Therapy Department)

ASSESSMENT OF THE HOME ENVIRONMENT

Toilet Suite Types and Pan Shapes

Table 4: Toilet suite type



Close Coupled Toilet	Back to Wall Suite	Wall Hung Suites
 (Aidacare, 2021b)	 (Aidacare, 2021b)	 (Aidacare, 2021b)
See Table 6 for installation requirements of each suite type		

Table 5: Toilet pan shapes

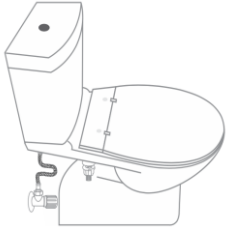

Round shaped	Oval (elongated) shaped	D – shaped	Square shaped
 (Buy Plumbing Online, 2020)	 (Buy Plumbing Online, 2020)	 (Buy Plumbing Online, 2020)	 (Buy Plumbing Online, 2020)
<p>Note: Bidet/douche seats are not compatible with square pan toilets currently in Australia.</p> <p>Note: Toilets with oval (elongated) shaped pans may be more appropriate for clients within the bariatric range due to being wider and longer than other toilet pans</p>			

Table 6: Bolt compatibility and water tap location of toilet types

	Close Coupled Toilet	Back to Wall Suite	Wall Hung Suits
Bidet Bolt Compatibility	Requires bottom fixing bolt compatibility	Requires top fixing bolt compatibility	Requires top fixing bolt compatibility
Typical water supply tap location	Features external water supply tap and external hose fitting	Water supply tap located in cistern	Water supply tap located within internal wall

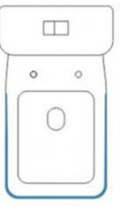
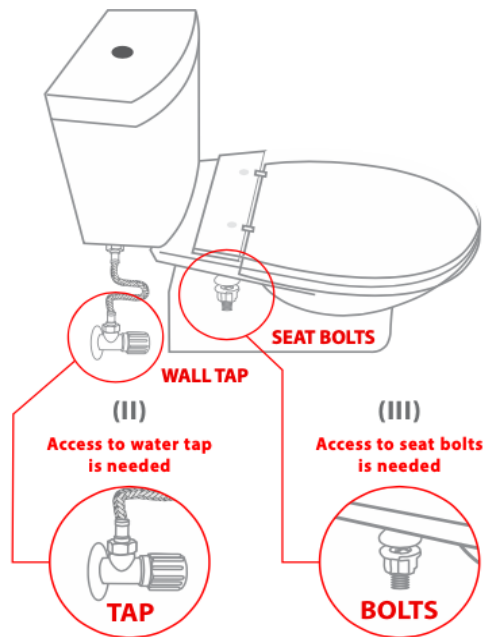

Figure 10: Example of toilet suite with bottom fixed bolts and water supply tap as an external fitting (Aidacare, 2021a)

Toilet Measurements

Some suppliers will require a pre-installation form to be complete by the Occupational Therapist prior to providing a quote e.g. Personal Independence Providers. Certain suppliers will site visit to do this themselves e.g. Aged Care Medical (see Table 13 for supplier forms). Please refer to Table 7 for working examples of taking measurements of the toilet pan. Measurements required may differ between suppliers, however taking measurements in Figure 11 is recommended at the first visit, if the therapist cannot access such forms.

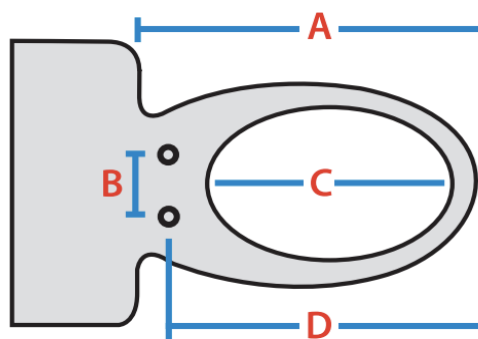





Figure 11: Labelled toilet pan diagram (The Bidet Shop, 2014)

Note: Toilet pan measurements should be taken with the toilet seat lifted, however it is preferable to have both the seat and lid removed.

Note: If measurement B cannot be taken with the toilet seat removed, it can be taken from the midpoint of each hinge.

Note: The following measurement guide was completed on a close coupled toilet. These toilets often have curved lips towards the back edge of the pan and therefore it is important that measurement D is a level measurement.

Table 7: Toilet pan measurement guide

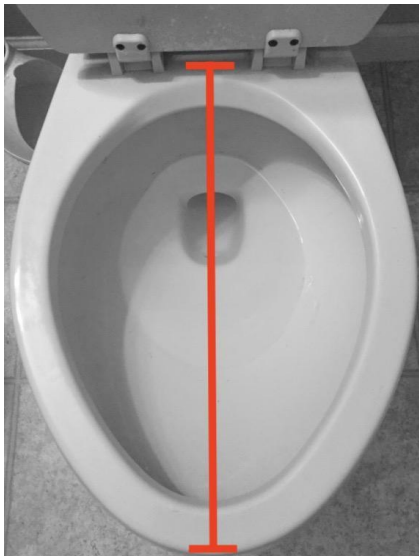
<p>Measurement A: Length of inside of toilet pan</p>  <p>(The Bidet Shop, 2014)</p>	<p>Measurement B: Width between the bolts</p> 
<p>Measurement C: Front of cistern to front of toilet pan</p>  <p>(The Bidet Shop, 2014)</p>	<p>Measurement D: Centre of seat bolts to front of toilet pan</p> 

Bidet Installation Requirements

Water supply tap:

- This is also known as a shut-off valve and serves the purpose of controlling the flow of water into a toilet. The water tap is the plumbing fixture that a bidet/douche toilet seat or handheld bidet will need to be connected to, to allow for water supply. Water supply taps can either be internal fittings (within the toilet wall or cistern) or external fittings (positioned on the exterior wall beside a toilet), depending on the toilet suite type (see Figure 6).
- Water supply taps that are located within a toilet cistern (i.e. in back to wall suites) will likely require an internal fitting kit in order to connect a bidet/douche toilet seat or handheld bidet to a toilet's water supply tap (additional expense).
- Water taps located within an internal wall (i.e. in wall hung suites) will require a certified plumber to install an alternate water supply route.

Internal fitting kit:

- These are used to supply water to a bidet product in cases where a toilet suite has a water supply tap located behind the toilet wall or in the cistern (i.e. where the water tap is not visible). It may also be required when a toilet's water supply tap is situated where there is no access to run a pipe around it.
- The estimated cost for an internal fitting kit is \$60.00 - \$100.00 (see Reece Plumbing or The Bidet Shop website for more details).

Bolts:

- Toilet seat bolts keep a toilet seat from sliding out of place on a toilet pan. Depending on the toilet suite type, bolts might be bottom fixing only (screwed into the bottom of the toilet seat) or top fixing only (screwed into the top of the toilet seat).
- It is important to determine the compatibility of a bidet/douche toilet seat with either top or bottom fixed bolt set up (see

Bathroom and Environmental Assessment

The following questions should be considered when assessing a client's bathroom/home environment. The '*Occupational Therapy Information Gathering Checklist*' can be used on a home visit to assist in gathering the relevant information (see appendix B).

a. Is there an existing power outlet within approx. 1.5 metres of the toilet?

If not, an electrician will be required to fit a power point outlet within 1.5 metres of the toilet for all electronic bidets (if possible, installation should be on the side of the toilet that the bidet's power cord travels from).

b. Does the client have an RCD (safety switch) installed in their electric meter box?

- This is a requirement for electricians to safely install electrical fixtures in the house. If this is not the case, an RCD will need to be installed at an additional cost to the client before an electrician can begin any installation.

c. Is the client's bathroom/toilet on the first or second floor of their house?

- If the toilet is on the first floor of a two story house the client might incur additional costs for any required electrical work.
- For second floor installations, confirm if there is access to roof space via a manhole as an electrician may need to enter the manhole to reach electrical wiring in the roof. If there is no manhole access, the installation of a power point may incur further costs for the electrician to run an external electrical conduit.

d. If a ground floor installation is required in a double storey dwelling, is the house on concrete slabs or stumps?

- A house built on stumps allows an electrician to access cables that run under the house. If a house is built on concrete slabs, there is no access to cables under the house and an electrician may then require access to the roof via a manhole.

e. If a toilet is separate to the main bathroom, consider the configuration of this space.

- Is there enough space for the client to effectively mobilise? If the toilet is located in a separate toilet room; will this space be suitable for the person long term i.e. if mobility deteriorates causing a reliance on assistive equipment and need for a larger turning circle.
- If a client requires a commode or mobility aid to effectively toilet, does the bathroom/separate toilet have ample space to accommodate excess adipose tissue or wide foot stance when seated (Peninsula Healthcare Network, 2015)?
- Is there an adjacent wall within arm's reach from the toilet that allows for a wireless bidet control to be mounted?

- f. **If a toilet is in the main bathroom (that has a shower in situ), does the client have a shower screen or curtain separating the shower and toilet?** If not, measurement of the distance (in millimetres) between the shower head (as it is fixed to the wall/bracket) and the toilet pan is required. Photos should also be taken of the whole bathroom showing clearly the distance and position of the toilet from the shower space.
- This information is required to determine the location of a power point installation if required, or whether a shower screen may need to be installed at an additional cost to separate an electrical power point from the splash area of a shower (to comply with wet area power regulations).

Photo Evidence of Environment

To further ensure the compatibility of a bidet, many installers will require pictures to be taken of a client's home, bathroom or surrounding rooms, to illustrate what is required for completion of the installation. There is some variability in photo requirements between installers, and as such they may require a combination of the photos presented in the 'Sample Photo Guide' section of the '*Occupational Therapy Information Gathering Checklist*' (see appendix B). Be aware that some bidet installation/home modification companies have their own pre-installation forms or checklists that may need to be referred to in conjunction with this OT specific checklist.

Note: *The 'Occupational Therapy Information Gathering Checklist' cannot usually be submitted in place of installer specific pre-installation forms. The purpose of the checklist is to guide the gathering of relevant preliminary information which can be used to fill out supplier specific forms (once the supplier is chosen), which may avoid the need for a second home visit.*

CLIENT EDUCATION

Following the installation of a bidet product, it is important to make owners aware of the maintenance and upkeep requirements of bidet equipment. To support educating clients on maintenance and upkeep, it might be helpful to provide client handout 'Occupational Therapy Bidet Information Form' (see Appendix C).

The most important points for maintenance and upkeep:

- Most bidet/douche seats will contain a built-in water filter to prevent small particles and sediments entering from the water supply tap to the bidet/douche seat. It is a requirement that water filters are changed by a certified plumber and the frequency of this should be determined by referring to the relevant supplier/manufacturer website information. Replacement water filters will likely be at the expense of the client (see Table 12).
- By law, an RPZD will require annual review and testing by a certified plumber (Standards Australia, 2020).
- Cleaning requirements may differ between products. It is important that cleaning information is supplied by the relevant bidet supplier/manufacturer and **NOT** from an Occupational Therapist, as any incorrect advice may put a clinician at risk of legal ramifications. It is advised that a care and maintenance information sheet is sought from the product supplier or provided to the client directly by the product supplier.

Note: To support client awareness of maintenance, upkeep and legal requirements, the 'Occupational Therapy Bidet Information Form' was developed (see Appendix C). Consider having the client sign the client consent section of the 'Occupational Therapy Information Gathering Checklist' prior to installation.

FUNDING OPTIONS

The sourcing and installation of bidets is often a costly process and may require extra funding to support clients financially. Occupational Therapists may consider cost-effective options that meet their client's needs and support them to obtain the cost of recommended assistive equipment, prior to proceeding with the prescription process.

Refer to Tables 8 and 9 for funding bodies that may be considered for subsidies for home modifications/assistive technologies of this type and/or provide assistance in closing funding gaps.

Table 8: Bidet funding information

VICTORIAN FUNDING OPTIONS			
<i>Funding Organisation</i>	<i>Eligibility Criteria</i>	<i>Application Form</i>	<i>Funding Available</i>
<p><u>Arthur Marsden Whiting Sympathy Fund</u></p> <p>Ph: 1300 133 472</p> <p>Email: https://www.eqt.com.au/contactus</p> <p>Website: https://www.eqt.com.au/philanthropy/grant-funding/folder-medical-grants/arthur-marsden-whiting-sympathy-fund</p>	<p>Clients must:</p> <ul style="list-style-type: none"> • Have a primary disability that impairs mobility • Be of the Protestant faith. • Reside in the State of Victoria. • Not suffer from alcoholism. • Meet the income eligibility criteria. • Be in need of financial assistance in order to obtain equipment, treatment, education or training, or any other assistance for the care of the person with a disability. <p>For further information: https://www.eqt.com.au/-/media/equitytrustees/files/philanthropy/forms-guides-reports/the-arthur-marsden-whiting-sympathy-fund--guidelines.pdf</p>	<p>https://equitytrustees.smartgrants.com.au/AMWhiting</p>	<p>Up to \$3000 over 12 months</p>
<p><u>Carer Gateway</u></p> <p>Ph: 1800 422 737</p> <p>Website: https://www.carergateway.gov.au/</p>	<p>Carers may receive financial assistance with home modifications or assistive equipment that serve to ease the carer burden. Funding requirements and eligibility are stringent and determined on a case by case basis.</p>	<p>Contact the funding body for additional information.</p>	<p>Carer gateway will contribute to part of the cost of equipment rather than covering the whole cost.</p>

Funding Organisation	Eligibility Criteria	Application Form	Funding Available
<p>Continence Aids Payment Scheme (CAPS) Ph: 8692 8400</p> <p>Email: info@continence.org.au</p> <p>Website: https://www.continence.org.au/get-support/financial-assistance/continence-aids-payment-scheme-caps</p>	<p>A person is eligible for CAPS if they are five years of age or older and have one of the following:</p> <ul style="list-style-type: none"> • A permanent and severe loss of bladder and/or bowel function caused by an eligible neurological condition • A permanent and severe loss of bladder and/or bowel function caused by another condition, provided the person has a Centrelink Pensioner Concession Card (whether as a primary cardholder or cardholder's dependent). <p>Individuals are ineligible if they:</p> <ul style="list-style-type: none"> • Are a high care resident in aged care home • Are an NDIS recipient • Are a DVA rehabilitation appliances program recipient • Have incontinence that is transient and manageable conservatively • Have incontinence as a result of a condition other than an eligible neurological condition and do not have Centrelink pensioner concession card entitlements. 	<p>https://www.health.gov.au/resources/publications/continence-aids-payment-scheme-application-guidelines-and-application-form</p>	<p>CAPS clients will receive a payment which is indexed annually. (The payment was \$609.70 for the financial year 2019-2020.)</p>
<p>Department of Veteran Affairs (DVA) Ph: 1800 550 457</p> <p>Email: rapgeneralenquiries@dva.gov.au</p> <p>Website: https://www.dva.gov.au/health-and-treatment/care-home-or-aged-care/services-support-you-home/aids-appliances-and-home#what-are-aids-equipment-and-home-modifications</p>	<p>General eligibility criteria:</p> <ul style="list-style-type: none"> • Individuals with a Veteran Gold Card • Individuals with a Veteran White Card for accepted service-related injury or condition <p>Criteria regarding bidets specifically:</p> <ul style="list-style-type: none"> • Must trial simpler aids and alternatives first • Functional, home and product assessment must be carried out 	<p>https://www.dva.gov.au/sites/default/files/dvaforms/d0992.pdf</p> <p>See OT considerations for bidet document</p> <p>https://www.dropbox.com/s/sl37rl8c73m9417/Bidet%20-%20OT%20Considerations%20V8%20Nov%2021.pdf?dl=0</p>	<p>DVA will cover the full cost of bidet and installation</p>

Funding Organisation	Eligibility Criteria	Application Form	Funding Available
<p>My Aged Care (MAC) Ph: 1800 200 422</p> <p>Email: https://www.myagedcare.gov.au/contact-us</p> <p>Website: Commonwealth Home Support Program (CHSP): https://www.myagedcare.gov.au/help-at-home/commonwealth-home-support-programme</p> <p>Home Care Program (HCP): https://www.myagedcare.gov.au/help-at-home/home-care-packages</p>	<p>CHSP:</p> <ul style="list-style-type: none"> • Aged 65 and over • Aged 50 and over, and on a low income, homeless, or at risk of being homeless <p>Check eligibility here: https://www.myagedcare.gov.au/am-i-eligible</p> <p>HCP: Eligibility is based on face to face assessment. Additionally, the recipient must also be one of the following:</p> <ul style="list-style-type: none"> • An older person who needs coordinated services to help them stay at home • A younger person with a disability, dementia or other care needs not met through other specialist services 	<p>Assessment application is through MAC: https://www.myagedcare.gov.au/assessment/apply-online</p>	<p>CHSP:</p> <ul style="list-style-type: none"> • Income dependant <p>HCP:</p> <ul style="list-style-type: none"> • Level 1 Basic care needs – \$9,026.45 a year • Level 2 Low care needs – \$15,877.50 a year • Level 3 Intermediate care needs – \$34,550.90 a year • Level 4 High care needs – \$52,377.50 a year
<p>National Disability Insurance Scheme (NDIS)</p> <p>Ph: 1800 800 110 Email: enquiries@ndis.gov.au</p> <p>Local area coordinator:</p> <p>Ph: 1300 275 634 Email: ndis.info@bsl.org.au</p> <p>Website: https://www.ndis.gov.au/applying-access-ndis</p>	<ul style="list-style-type: none"> • Aged between 7 and 65 • Australian resident <p>One or more of the following:</p> <ul style="list-style-type: none"> • Require support from a person because of a permanent and significant disability • Use special equipment because of a permanent and significant disability • Need support now to reduce future needs 	<p>https://www.ndis.gov.au/how-apply-ndis/what-access-request-form#access-request-form</p>	<p>Funding amount varies on a case by case basis</p>

Funding Organisation	Eligibility Criteria	Application Form	Funding Available
<p>State-Wide Equipment Program (SWEP)</p> <p>Ph: 1300 747 937</p> <p>Email: swep@bhs.org.au</p> <p>Website: https://swep.bhs.org.au</p> <p>Victorian Aids & Equipment Program: https://www2.health.vic.gov.au/ageing-and-aged-care/supporting-independent-living/aids-and-equipment</p>	<ul style="list-style-type: none"> Victorian resident living independently in the community, OR a person holding a temporary or permanent protection visa OR are an asylum seeker with a permanent/long term disability and/or frail aged. Does not receive other government funding for AT items Cannot claim AT items through private health insurance <p><i>Note: SWEP will not fund home modifications for Office of Housing tenants. This includes all bidet toilet seats, handheld bidets and standalone bidets</i></p>	<p>https://swep.bhs.org.au/for-prescribers.php</p>	<p>Up to \$4400 – no including ongoing maintenance as this is the responsibility of the client</p>
<p>Transport Accident Commission (TAC)</p> <p>Ph: 1300 654 329</p> <p>Email: https://www.tac.vic.gov.au/about-the-tac/contact-us?drop=2#onlinecontactform</p> <p>Website: https://www.tac.vic.gov.au/providers/type/occupational-therapist/working-with-the-tac</p>	<ul style="list-style-type: none"> Relevant transport accident occurred to a Victorian resident or within Victoria to a non-resident Accident must be reported Injury is physical or mental Must not be at fault for accident 	<p>https://www.tac.vic.gov.au/providers/type/occupational-therapist/treating-a-client/assessment-forms</p>	<p>Funding amount varies on a case by case basis</p>
<p>Walter and Eliza Hall Trust</p> <p>Ph: (02) 9264 9480</p> <p>Email: wehalltrust@bigpond.com</p> <p>Website: https://www.wehalltrust.org.au/</p>	<p>Will fund almost any purpose considered necessary for the client's health and wellbeing. As it is a last resort fund, can only provide assistance where needs are desperate and assistance is necessary to maintain the minimum standards of safety, security, protection and comfort for the individual or family. All other means must have been exhausted.</p>	<p>https://www.wehalltrust.org.au/apply-for-assistance</p>	<p>Individuals apply for the amount of funding desired</p>

Funding Organisation	Eligibility Criteria	Application Form	Funding Available
<p>YoungCare Ph: 1800 844 727</p> <p>Email: youngcareconnect@youngcare.com.au</p> <p>Website: https://www.youngcare.com.au/what-we-do/grants/</p>	<ul style="list-style-type: none"> • Aged between 16 and 65 • Have a permanent diagnosed physical disability (e.g. Multiple Sclerosis, Cerebral Palsy, brain or spinal cord injury) • People with or without NDIS plans can apply • People with NDIS plans must show evidence of additional need 	<p>https://www.youngcare.com.au/wp-content/uploads/Home_Support_Grants_information_guide_2-2020V2.pdf</p>	<p>\$10,000, or \$20,000 in extreme circumstances</p>

Note: In some circumstances it may be appropriate to consider local community groups (E.g. Lions club, Rotary, RSL, local churches etc.) to seek funding subsidies through fundraising opportunities.

Table 9: National funding bodies

<p><u>Australian Capital Territory</u></p>	<p>Oxygen and Equipment Services Website: https://www.health.act.gov.au/services-and-programs/rehabilitation/oxygen-and-equipment-services</p> <p>National Disability and Insurance Scheme Website: https://www.ndis.gov.au/</p>
<p><u>New South Wales</u></p>	<p>Aids and Equipment Program Website: http://www.enable.health.nsw.gov.au/services/aep</p> <p>National Disability and Insurance Scheme Website: https://www.ndis.gov.au/</p>
<p><u>Northern Territory</u></p>	<p>National Disability and Insurance Scheme Website: https://www.ndis.gov.au/</p>
<p><u>Queensland</u></p>	<p>Medical Aids Subsidy Scheme Website: https://www.health.qld.gov.au/mass</p> <p>National Disability and Insurance Scheme Website: https://www.ndis.gov.au/</p>
<p><u>South Australia</u></p>	<p>Domiciliary Equipment Services Website: https://www.des.sa.gov.au/</p> <p>National Disability and Insurance Scheme Website: https://www.ndis.gov.au/</p>
<p><u>Tasmania</u></p>	<p>TasEquip Website: https://www.dhhs.tas.gov.au/service_information/services_files/RHH/treatments_and_services/tasequip</p> <p>National Disability and Insurance Scheme Website: https://www.ndis.gov.au/</p>
<p><u>Western Australia</u></p>	<p>Community Aids and Equipment Program Website: http://www.disability.wa.gov.au/services-support-and-eligibility/services-supports-and-eligibility-new/services/services-provided-by-the-commission/equipment-and-technology/community-aids-and-equipment-program-caep-/</p> <p>National Disability and Insurance Scheme Website: https://www.ndis.gov.au/</p>



PRODUCT LISTS

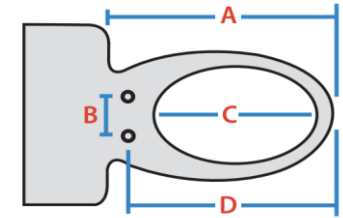

Local suppliers may have equivalent stock. Refer to the state Independent Living centre (ILC) websites for additional supplier information - <https://ilcaustralia.org.au/>



Refer to labelled diagram when determining toilet pan compatibility

Table 10: Bidet/douche toilet seat information

BIDET/DOUCHE TOILET SEATS									
Supplier/ Cost (Approx.)	Product Name	Toilet Pan Compatibility <i>(Bidet seat will fit a toilet pan with following dimensions)</i>	Installation Requirements	SWL (KG)	Key Features				
					Detachable Lid	Adjustable Nozzles	Feminine Wash	Rear Wash	Drying
Bunnings Warehouse: \$100 PIP: Price will be quoted with installation	EVEKARE Water powered Bidet Toilet Seat 	Standard Seat: A: > 570mm B: 125mm - 190mm C: > 340mm D: 452mm - 496mm	Electrical: power point not required	150			✓	✓	
Bunnings Warehouse: \$400 PIP: Price will be quoted with installation	 EVEKARE Smart Bidet Toilet Seat	Standard seat: A: > 570mm B: 125mm - 190mm C: > 340mm D: 452mm - 496mm	Electrical: power point required	150			✓	✓	✓

Supplier/ Cost (Approx.)	Product Name	Toilet Pan Compatibility <i>(Bidet seat will fit a toilet pan with following dimensions)</i>	Installation Requirements	SWL (KG)	Key Features				
					Detachable Lid	Adjustable Nozzles	Feminine Wash	Rear Wash	Drying
The Bidet Shop: \$900	National Bidet N800 	Standard Seat: A: min 496mm B: 140mm - 195mm C: min 320mm (330 recommended) D: min 400mm	Electrical: power point required Water filter required	120	✓	✓	✓	✓	✓
The Bidet Shop: \$900 PIP: \$1000 Aidacare: \$1100	COWAY BA15E Electronic Bidet 	Elongated Seat: A: min 520mm B: 140mm - 195mm C: min 340mm D: min 400mm	Electrical: power point required	120	✓		✓	✓	





Supplier/ Cost (Approx.)	Product Name	Toilet Pan Compatibility <i>(Bidet seat will fit a toilet pan with following dimensions)</i>	Installation Requirements	SWL (KG)	Key Features				
					Detachable Lid	Adjustable Nozzles	Feminine Wash	Rear Wash	Drying
The Bidet Shop: \$1-2k PIP: \$2000 Aidacare: \$2000	COWAY BA08 Electronic Bidet 	Standard Seat: A: min 500mm B: 140mm - 195mm C: min 330mm D: min 400mm Elongated Seat: A: min 520mm B: 140mm - 195mm C: min 340mm D: min 400mm	Electrical: power point required Water filter required Not compatible with wall hung toilets or back to wall suites	200	✓	✓	✓	✓	✓
The Bidet Shop: \$1500	ECO Bidet R500 	Standard Seat: A: min 480mm B: 140mm - 195mm C: min 320mm (330mm recommended) D: min 400mm Elongated Seat: A: min 520mm B: 140mm - 195mm C: min 340mm D: min 400mm	Electrical: power point required Water filter required	120	✓	✓	✓	✓	✓

Table 11: Bidet attachments/accessories information

BIDET ATTACHMENTS/ACCESSORIES			
Supplier/ Cost (Approx.)	Product Name	Product details	Additional information
Bunnings Warehouse: \$30-60	EVEKARE Bidet Spray 	Includes: Wall mounted holder Hand spray Hose of 1.2m length	<ul style="list-style-type: none"> • Available in chrome plated brass, matte black plated brass, and white PVC. • Additional RPZD required
Bunnings Warehouse: \$80 - 100	EVEKARE Bidet Spray Kit with Integrated Holder 	Includes: 1x Wall mounted holder bracket 1x Hand spray 1x Flexible hose- 1.2 m 1x Dual shut off valve 1x Dual check valves in the hand piece for backflow prevention	<ul style="list-style-type: none"> • Appropriate for a new installation • Additional RPZD may be required – check with Bunnings Warehouse or a certified plumber
Handspray: \$100	Standard Handspray kit 	Kit includes: 1x Stainless Steel Handspray 1x 1.2m Flexible Hose 1x Handspray Wall Holder 1x Screw	<ul style="list-style-type: none"> • Appropriate for existing installations i.e. wanting to replace an existing hose • Assumes that an RPZD is already installed





Supplier/ Cost (Approx.)	Product Name	Product details	Additional information
Handspray: \$200	Complete Handspray kit 	Kit includes: 1x Stainless Steel Handspray 1x 1.2m Flexible Hose 1x Handspray Wall Holder 1x Screw 1x Dual Check Backflow 1x Water Diverter 1x Braided Hose	<ul style="list-style-type: none"> • Appropriate kit for new hose installations • Additional RPZD required
LueLue Bidet: \$150	LUELUE Bidet LB100 	SWL 120kg Suited to round type toilets No electricity required, only main pipe access beneath the toilet	<ul style="list-style-type: none"> • Not compatible with back to wall toilets • Adjustable water pressure • Cold water only unless hot/warm tap available • Supplied with Dual Check Valve (Dual CV) Back Flow Prevention • Must be installed by certified plumber
The Bidet Shop Accessories: \$150 (50mm) \$200 (80mm)	<ul style="list-style-type: none"> • Throne Toilet Seat Raiser (50mm or 80m) • Removable Toilet Arms • Dignity Commode • Aerolift Toilet Lift 	Product Brochure https://www.thebidetshop.com.au/pages/Medical-%26-Disability.html Website https://www.thebidetshop.com.au/categories/Bidet-Product-Range/	<ul style="list-style-type: none"> • Compatibility with specific bidets may vary. • Please note that a toilet seat raiser of any size can NOT be used to replace an RPZD.

Table 12: Additional maintenance parts for bidets

ADDITIONAL PARTS FOR ONGOING MAINTENANCE		
<i>Supplier/Cost (Approx.)</i>	<i>Product Name</i>	<i>Compatible bidets</i>
The Bidet Shop: \$70	Coway BA07 BA08 Bidet Water Filter Replacement 2 x pcs 	COWAY BA08 Electronic Bidet
The Bidet Shop: \$70	Eco 200 300 500 Bidet Water Filter Replacement 2 x pcs 	Eco Bidet R500 National Bidet N800
<p>Note: All above items should be installed by a certified plumber. For ongoing maintenance of the compatible bidets, water filters need to be replaced by a certified plumber. Contact relevant supplier for information on water filter replacements.</p>		

SUPPLIER AND INSTALLER LISTS

Table 13: Bidet supplier and installer information containing Victorian contact details

SUPPLIER/ INSTALLER INFORMATION							
<i>Name/ Key Contact</i>	<i>Supplier</i>	<i>Installer</i>	<i>Showroom</i>	<i>Australian Standards Compliant</i>	<i>Funding Contracts</i>	<i>Warranty</i>	<i>Pre-Prescription / Installation Quotation Forms</i>
<p>The Bidet Shop</p> <p>Location (showroom): 1686, Dandenong Road, Oakleigh East VIC, 3166</p> <p>PH (OT direct line): 03 9081 0344</p> <p>Cheryl Scott (Showroom contact): 03 9544 9611</p> <p>E: OT@thebidetshop.com.au</p> <p>W: www.thebidetshop.com.au</p>	✓	X	✓	✓	<p>NDIS</p> <p>SWEP</p> <p>My Aged Care</p> <p>DVA</p>	<p>12-month all-inclusive warranty for covers</p> <p>100% replacement of parts and labour</p> <p>Extended warranty available for an additional 2 years \$100</p>	<p>Welcome package including pre-prescription form, is sent to OT following an expression of interest via OT direct line.</p>
<p>Personal Independence Providers</p> <p>Location: 1/14 Charnfield Ct, Thomastown VIC, 3074</p> <p>PH: 1300 657 016</p> <p>E: PIP@haleberry.com.au</p> <p>W: www.haleberry.com.au</p>	✓	✓	X	✓	<p>NDIS</p> <p>SWEP</p> <p>HCP</p> <p>DVA</p> <p>TAC</p> <p>WorkCover</p>	<p>12 months from the date of installation</p>	<p>PIP bidet installation checklist</p>

Name/ Key Contact	Supplier	Installer	Showroom	Australian Standards Compliant	Funding Contracts	Warranty	Pre-Prescription / Installation Quotation Forms
Aidacare Location (showroom): 82 Albion Street Brunswick East VIC, 3057 PH: 03 9981 2101 E: online@aidacare.com.au E: sales@aidacare.com.au W: www.aidacare.com.au	✓	✓ Quote Estimate: \$1000- \$1500 Services a 50-100km radius from Melbourne CBD – Regional locations serviced at an additional cost (38approx. \$200-400)	✓	✓	NDIS SWEP My Aged Care	Products come with manufacturer’s warranty and differ product to product	‘Aidacare Remote Evaluation Checklist’ <i>Noted amendments on this form: Contact no. and email are no longer active & ‘part 5’ is no longer applicable.</i> https://www.aidacare.com.au/globalassets/knowledge/resources-page/cat-service-user-guides/bidet-remote-evaluation-checklist.pdf
Aged Care and Medical (online) PH: 1300 003 930 E: homemods@agedcaremedical.com.au Contact: Michelle Dennis michelle@agedcareandmedical.com.au W: www.agedcareandmedical.com.au	✓	✓	X	✓	NDIS SWEP My Aged Care	Dependant on site visit, product recommendation and installation process	‘Product Enquiry Form’ https://agedcareandmedical.com.au/pages/product-enquiry-form Contact directly for supply and installation quotes

Name/ Key Contact	Supplier	Installer	Showroom	Australian Standards Compliant	Funding Contracts	Warranty	Pre-Prescription / Installation Quotation Forms
Bunnings Warehouse (Coburg) Location: 64-96 Gaffney St, Coburg North, 3058 PH: 03 8371 8400 W: www.bunnings.com.au	✓	X	Product display varies store to store	✓	OT to apply to relevant funding body	Variability between products Returns available for change of mind (only if packaging has not been opened) and faulty products within 30 days of purchase.	Nil available
Reece Plumbing (Coburg) Location: 164 Newlands Rd, Coburg North VIC, 3058 PH: 03 9353 9410 W: www.reece.com.au	✓	X	Product display varies store to store	✓	OT to apply to relevant funding body	Variability between products 10-15-year product replacement warranty (for domestic use only) and 12-month warranty on parts and labor Warranty is <u>void</u> if products are not installed by licensed plumber	Nil available

<i>Name/ Key Contact</i>	<i>Supplier</i>	<i>Installer</i>	<i>Showroom</i>	<i>Australian Standards Compliant</i>	<i>Funding Contracts</i>	<i>Warranty</i>	<i>Pre-Prescription / Installation Quotation Forms</i>
Burden's bathrooms Location (showroom): 101 Whitehorse Rd Balwyn VIC, 3103 PH (Balwyn centre): 03 9817 4521 PH (product advice): 1300 202 010 W: https://burdensbathrooms.com.au/ E: balwynsr@burdens.com.au	✓	X	✓	✓	OT to apply to relevant funding body	Variability between products	Nil available
LueLue Bidets (online store) PH: 1300 069 660 E: info@luelue.com.au W: www.lueluebidet.com.au	✓ Free delivery over \$200	X	N/A	✓	OT to apply to relevant funding body	2-year product warranty	Nil available
Handspray (online store) PH: 02 8039 4558 E: sales@handspray.com.au W: www.handspray.com.au	✓ \$15 flat rate delivery per Handspray	X	N/A	✓	OT to apply to relevant funding body	12-month full replacement warranty on normal use of all handheld bidet hoses	Nil available

Name/ Key Contact	Supplier	Installer	Showroom	Australian Standards Compliant	Funding Contracts	Warranty	Pre-Prescription / Installation Quotation Forms
Mobility Access Modifications Location: 18 Dairy Dr, Coburg North VIC, 3058 PH: 03 9350 4400 E: mam@mobilityaccess.com.au W: www.mobilityaccess.com.au	X	✓ Quote Estimate: \$1500 - \$2000 Services greater metro Melbourne, Geelong and Pakenham	N/A	✓	NDIS SWEP HCP TAC DVA WorkCover	Subject to requirements of product suppliers	Request a quote via contact us form: www.mobilityaccess.com.au/contact For specific funding body quote requirements, visit: https://www.mobilityaccess.com.au/ot-information
Sketch Industries Location (head office): 6 Lewin Street Carrum Downs VIC, 3201 Mob: 0429 103 939 E: sketchindustries@hotmail.com	X	✓ Services greater Melbourne and regional Victoria	N/A	✓	OT to apply to relevant funding body	6-year warranty on plumbing workmanship valued over \$750 - requires a certificate of compliance (AS/NZS 3500)	Contact directly for quote
Luminix LMX Construction and Builders Location: 22 Jacana Avenue, Templestowe Lower VIC, 3107 Mob: 0427 262 844 W: www.rcrums.com E: tony.simmons@luminix.com	X	✓ Services greater metro Melbourne (depending on tradesman location)	N/A	✓	SWEP	6-year warranty on plumbing workmanship valued over \$750 - requires a certificate of compliance (AS/NZS 3500)	Contact directly for quote

Name/ Key Contact	Supplier	Installer	Showroom	Australian Standards Compliant	Funding Contracts	Warranty	Pre-Prescription / Installation Quotation Forms
Whistler Plumbing Services Location: mobile service Mob (Robert Whistler): 0447 758 631 E: robert@whistlersplumbing.com.au	X	✓ Services greater metro Melbourne	N/A	✓	OT to apply to relevant funding body	6-year warranty on plumbing workmanship valued over \$750 - requires a certificate of compliance (AS/NZS 3500)	Contact directly for quote
Beachside plumbing Location: mobile service PH: 1300 232 241 PH: 03 9512 0007 W: http://www.beachsideplumbing.com.au/ E: water@beachsideplumbing.com.au	X However, supply of products can be organised by Beachside Plumbing	✓ Plumbers and electricians available Services greater metro Melbourne	N/A	✓	OT to apply to relevant funding body	6-year warranty on plumbing workmanship valued over \$750 - requires a certificate of compliance (AS/NZS 3500) On works valued under \$750, there is 6-year warranty for faulty installations and additional 12-month warranty on repairs for spontaneous damage/problems.	Contact directly for quote via email: water@beachsideplumbing.com.au . Beachside will do a site assessment and provide a quote.
John Kennedy Plumbing & Building services Location: 1044 Dandenong Rd, Carnegie VIC, 3163 PH: 03 9822 1241 W: https://www.jkpbs.com.au/ E: info@jkpbs.com.au	X	✓ Plumbers and electricians available Services greater metro Melbourne	N/A	✓	NDIS SWEP DVA	6-year warranty on plumbing workmanship valued over \$750 - requires a certificate of compliance (AS/NZS 3500)	No obligation to submit a form. Free quotes via photos over email or site visits if needed.

Disclaimer

Authors, sponsors or Merri Health does not warrant or accept any liability in relation to the quality, operability or accuracy of the material.

The material is made available on the understanding that it will have no liability (including but not limited to liability by reason of negligence) to the users of the document for any loss, damage, cost or expense whether direct, indirect consequential or special, incurred by, or arising by reason of, any person using or relying on the material and whether caused by reason of any error, omission or misrepresentation in the material or otherwise. Users of the document will be responsible for making their own assessment of the material and should verify all relevant representations, statements and information with their own professional advisers.

Furthermore, whilst the material is considered to be true and correct at the date of publication, changes in circumstances after the time of publication may impact upon the accuracy of the material. The material may change without notice and the authors are not in any way liable for the accuracy of any information printed and stored by a user. Changes are periodically added to the material.

The authors/owners take no responsibility for the accuracy, currency, reliability and correctness of any information included in the material provided by third parties nor for the accuracy, currency, reliability and correctness of links or references to information sources (including Internet sites).

REFERENCES

- Aidacare. (2021a). *Guide - Locating measurements/water tap / seat bolts* [Image]. Retrieved 25 July 2021, from <https://www.aidacare.com.au/globalassets/knowledge/resources-page/cat-service-user-guides/bidet-remote-evaluation-checklist.pdf>
- Aidacare. (2021b). *Style guide - close coupled / back to wall / wall hung* [Image]. Retrieved 25 July 2021, from <https://www.aidacare.com.au/globalassets/knowledge/resources-page/cat-service-user-guides/bidet-remote-evaluation-checklist.pdf>
- Australian Building Codes Board. (2019). *Handbook: Cross-connection control*. <https://www.abcb.gov.au/resource/handbook/cross-connection-control>
- Australian Building Codes Board. (2021). *Toilet douche seats* (WMTS-051). <https://consultation.abcb.gov.au/engagement/wmts-051-2020-public-consultation/>
- Australian Commission on Safety and Quality in Healthcare. (2005). *National Patient Safety Education Framework*. <https://www.safetyandquality.gov.au/sites/default/files/migrated/National-Patient-Safety-Education-Framework-2005.pdf>
- Bassola, B., & Lusignani, M. (2017). Self-care in people with motor neuron disease: An integrative review. *Journal Of Neuroscience Nursing*, 49(5), 311-317. <https://doi.org/10.1097/jnn.0000000000000303>
- Buy Plumbing Online. (2020). How to replace a toilet seat with our easy fitting guide. Retrieved 9 August 2021, from <https://buyplumbingonline.co.uk/blog/post/how-to-replace-a-toilet-seat.html>
- Department of Health and Ageing. (2020). *Protocol for reviewing existing MBS items - Quality Framework Review #2: Items for the surgical treatment of obesity*. <https://www1.health.gov.au>
- Department of Health and Human Services. (2017). *Home modifications prescriber manual*. <https://swep.bhs.org.au/precriber-manuals.php>
- ETAC. (2021). Etac swift mobile 2 [image]. https://www.etac.com/products/bathroom-aids/mobile-shower-commodes/etac-swift-mobil-2/?fbclid=IwAR3UxYToj2U378OebfPL0S3Kd59EQ3lAPwYAdlYTu2N2L_HbsToN4kH5vSc#features-anchor
- Feijoo-Bandin, S., Rodriguez-Penas, D., Garcia-Rua, V., Mosquera-Leal, A., Gonzalez-Juanatey, J. R., & Lago, F. (2016). Adipokines at the cardiovascular system: role in health and disease. *SM J Endocrinol Metab*, 2(1), 1009-1016.

- Gresham, M. (2018). *The clinical utility of the electronic toilet-top bidet for Australian nursing home residents and staff*. [Doctoral dissertation, University of Sydney]. Sydney Digital Theses. <https://ses.library.usyd.edu.au/handle/2123/19638>
- Havlickova, B., & Weyandt, G. H. (2014). Therapeutic management of anal eczema: an evidence-based review. *International journal of clinical practice*, 68(11), 1388-1399.
- K. & J. Woolley Master Plumbers. (2014). *The difference between a bidet and a bidette*. <https://www.woolleysplumbing.com.au/blog/2014/01/the-difference-between-a-bidet-and-a-bidett/>
- Kanayama Katsuse, A., Takahashi, H., Yoshizawa, S., Tateda, K., Nakanishi, Y., Kaneko, A., & Kobayashi, I. (2017). Public health and healthcare-associated risk of electric, warm-water bidet toilets. *Journal Of Hospital Infection*, 97(3), 296-300. <https://doi.org/10.1016/j.jhin.2017.07.021>
- Kim, Y. M., Kim, J. Y., Lee, M. Y., Choi, S. J., Oh, S. Y., Shim, J. Y., & Roh, C. R. (2019). Prospective study of bidet toilet use: association of abnormal vaginal colonization and preterm birth in high-risk pregnant women. *Journal of Obstetrics and Gynaecology Research*, 45(6), 1134-1142.
- Msengana, Z., De Witt, P., Owen, A., & Franzsen, D. (2019). Upper limb mobility and personal management in patients with stroke attending occupational therapy at a tertiary hospital in Gauteng. *South African Journal Of Occupational Therapy*, 49(3), 6-16. <https://doi.org/10.17159/2310-3833/2019/vol49n3a3>
- National Health and Medical Research Council. (2013). Clinical practice guidelines for the management of overweight and obesity in adults, adolescents and children in Australia. <https://www.nhmrc.gov.au/about-us/publications/clinical-practice-guidelines-management-overweight-and-obesity>
- Padilla, C., Ferreyro, F., & Arnold, W. (2021). Anthropometry as a readily accessible health assessment of older adults. *Experimental Gerontology*, 111464. <https://doi.org/10.1016/j.exger.2021.111464>
- Peninsula Health Care Network. (2015). *Occupational Therapy evidence-based practice guidelines for the prescription of bariatric home modifications* (1st ed., pp. 11-12). <https://www.homemods.info/resources/publications-by-others/access/occupational-therapy-evidence-based-practice-guidelines-for-the-prescription-of-bariatric-home-modifications>
- Queensland Health. (2019). Are you pooing properly?. Retrieved August 17, 2021 from <https://www.health.qld.gov.au/news-events/news/how-to-poo-properly-sit-squat-healthy>
- Reece Plumbing. (2020). *Roca The Gap Back to Wall Bidet 1 Taphole White* [image]. <https://www.reece.com.au/product/toilets-c469/bidets-c1644/roca-the-gap-back-to-wall-bidet-1-taphole-9504439>

- Standards Australia. (2010a). *Water supply- Backflow prevention devices- Part 1: Materials, design, performance requirements* (AS 2845.1). <https://www-saiglobal-com.ez.library.latrobe.edu.au/online/autologin.asp>
- Standards Australia. (2010b). *Water supply - Backflow prevention devices - Part 2: Registered air gaps and registered break tanks* (AS 2845.2). <https://www-saiglobal-com.ez.library.latrobe.edu.au/online/autologin.asp>
- Standards Australia. (2019). *Sanitary plumbing products - Personal hygiene fixtures and appliances - Bidets and bidettes* (AS 1172.3). <https://www-saiglobal-com.ez.library.latrobe.edu.au/online/autologin.asp>
- Standards Australia. (2020). *Water supply – Backflow prevention devices – Part 3: Field testing and Maintenance of testable devices* (AS/NZS 2845.3). <https://www-saiglobal-com.ez.library.latrobe.edu.au/online/autologin.asp>
- Standards Australia. (2021a). *Electrical installations (AS/NZS 3000 Amendment 2)*. <https://www-saiglobal-com.ez.library.latrobe.edu.au/online/autologin.asp>
- Standards Australia. (2021b). *Plumbing and drainage- Part 1: Water services* (AS/NZS 3500.1). <https://www-saiglobal-com.ez.library.latrobe.edu.au/online/autologin.asp>
- Standards Australia. (2021c). *Design for access and mobility – Part 1: General requirements for access-new building work* (AS 1428.1). <https://www-saiglobal-com.ez.library.latrobe.edu.au/online/autologin.asp>
- Tanguay, S. (2020). *The big picture – Seating the bariatric client*. [webinar]. Motion Concepts. https://www.motionconcepts.com/Webinar_landing%20page.html?fbclid=IwAR3pvHVvAS9oZij4L7CT0Np0EBwDIBnXimKVs24oyGMv4SLI4Hhn1SfvW9s
- The Bidet Shop. (2014). *Pan measurement guide* [Image]. <https://www.thebidetshop.com.au/pages/Installation.html>
- Tsunoda, A., Otsuka, Y., Toguchi, A., Watanabe, K., Nishino, R., & Takahashi, T. (2019). Survey on bacterial contamination of bidet toilets and relation to the interval of scrubbing these units. *Journal of Water And Health*, 17(6), 863-869. <https://doi.org/10.2166/wh.2019.234>
- Vansteenkiste, S., Reneman, M., van der Eerden, P., Soer, R., Dijkstra, P., & van der Sluis, C. (2017). Upper limb functional capacity of working patients with osteoarthritis of the hands: A cross-sectional study. *Journal of Hand Therapy*, 30(4), 507-515. <https://doi.org/10.1016/j.jht.2017.01.003>
- Wales, K., Clemson, L., Lannin, N., & Cameron, I. (2016). Functional assessments used by occupational therapists with older adults at risk of activity and participation limitations: A systematic review. *PLOS ONE*, 11(2), 1-20. <https://doi.org/10.1371/journal.pone.0147980>

Wilson, S., & Landry, G. (2014). *Task analysis: An individual and population approach* (3rd Ed.). American Occupational Therapy Association Press.

World Health Organization. (2003). World health organization global strategy on diet, physical activity and health. Geneva: WHO.

APPENDICES

Appendix A - Key Stakeholders Consulted

Key individuals:

- Craig Jackman – Senior Occupational Therapist
- Lauren Hennessy – Senior Occupational Therapist
- Advisory Occupational Therapists

Governing and/or funding bodies:

- Alfred Health
- Master Plumbers Association
- Office of housing
- SWEP
- Victorian Building Authority

Suppliers and/or manufacturers:

- Active Rehabilitation Equipment (Bendigo)
- Aged Care and Medical
- Aidacare
- Alphacare
- Bunnings Warehouse
- Burdens Bathrooms
- Evekare
- Hospequip
- Indicare
- Novice Healthcare
- Personal Independence Providers (also installers)
- Reece Plumbing
- Roca Bathroom Australia
- The Bidet Shop

Installers and/or home modification companies:

- Beachside Plumbing
- John Kennedy Plumbing & Building Services
- Luminix Construction Builders
- Mobility Access Modifications
- Sketch Industries
- Whistler Plumbing Services

Appendix B - Bidet Information Gathering Checklist

Client name:	Assessment date:
Client ID:	Clinician:

OCCUPATIONAL THERAPY INFORMATION GATHERING CHECKLIST

HOME SETUP	
Is the home single or double storey? <i>(This will determine where the existing electrical wiring is located i.e. in roof, floor and/or walls)</i>	Single / Double
Is the house built on concrete slabs or stumps? <i>(Concrete slabs limit an electrician's access to cables underneath the house)</i>	Slabs / Stumps
Is the home double brick? <i>(Helps determine where the existing internal plumbing or electrical wiring can be accessed from)</i>	Y / N
Is there access to the roof space via a manhole? <i>(A manhole provides access to electrical cables in a house's roof space)</i>	Y / N
TOILET/BATHROOM SETUP	
Is the toilet in a bathroom or separate to the bathroom? <i>(Location may impact wet area regulations and power outlet)</i>	Bathroom / Separate
What level is the toilet/bathroom on?	First level / Second level / Third level +
What shape is the toilet pan? <i>(Will help to determine toilet compatibility with a bidet/douche toilet seat)</i> <i>Note: Oval shaped seats are commonly associated with bariatric toilets.</i> <i>Note: Square shaped toilets are not compatible with Australian compliant bidet/douche toilet seats. The toilet suite may need to be replaced to accommodate.</i>	 <div style="display: flex; justify-content: space-around; text-align: center;"> 'D' Round Square Oval </div>
Is there a handheld shower hose (HSH) in the bathroom?	Y / N
Is there a shower screen/curtain between the shower and toilet? <i>(A HSH increases the likelihood of water splashing onto electrical fixtures, although this risk is minimised if a shower screen/curtain is insitu)</i>	Y / N
What is the distance between the shower head and toilet pan? <i>(Measure from top of shower head as it is fixed to the wall/bracket, to the toilet pan. Supply photo evidence of bathroom layout to supplement this information.)</i>	_____mm
Where is the water tap located? <i>(A water tap that is external to the toilet can typically be found to the left of a toilet on the adjacent wall. The location of the water tap will determine if an internal fitting kit is required.)</i>	In wall / In cistern / External to toilet
Access to toilet seat bolts is: <i>(Location of toilet bolts will help determine the bolt compatibility of a bidet/douche toilet seat)</i>	Bottom fixed / Top fixed
Is there an existing power point behind or beside the toilet within 1.5 metres? <i>(This will help to determine whether an additional power point will need to be installed to power an electronic bidet/douche toilet seat)</i>	Y / N
METER BOX/MAIN SWITCHBOARD	
Is the meter box located inside or outside the home?	Y / N
Is there a safety switch (RCD) fitted on the meter box? <i>(An RCD switch is required to allow an electrician to safely install electrical fixtures)</i>	Y / N

Client name:

Assessment date:

Client ID:

Clinician:

TOILET MEASUREMENT DIAGRAM

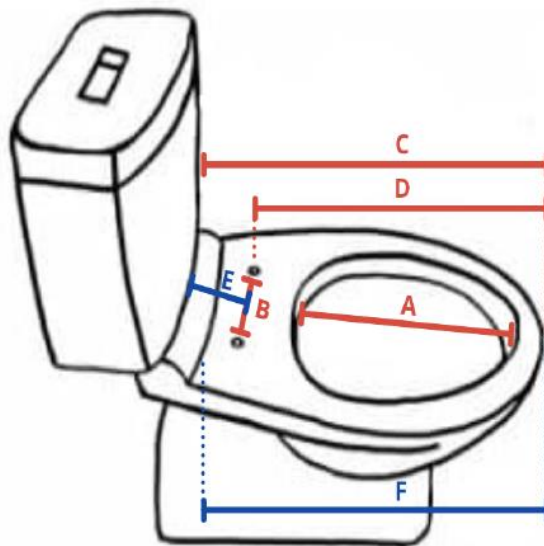

Note: Labelled letters may vary across forms required by installers. Please use these as a guide only.

Note: Pan measurements need to be taken with a toilet seat and lid up or preferably with the seat and lid removed from the hinges.

A: Length of inside of toilet pan	_____ mm
B: Width between the bolts	_____ mm
C: Front of cistern to front of toilet pan	_____ mm
D: Centre of seat bolts to front	_____ mm
E: Front of cistern to center of bolts	_____ mm
F: Front of lip to front of pan	_____ mm

SAMPLE PHOTO GUIDE

Note: Remember to refer to individual installer forms/checklists if available, for specific photo requirements. Requirements may vary based on individual house configuration and structure.

Aerial photo of toilet with seat up



Aerial photo of toilet with seat down



Front photo



Side photo of toilet



Side photo of toilet showing tap (if visible)



Wide photo of toilet room with power point in view



Laneway directly outside toilet



Photo of home water meter



Wide shot of front of home



Closeup of meter box showing safety switch (RCD)

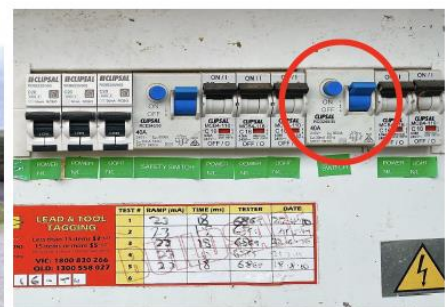

OCCUPATIONAL THERAPY BIDET INFORMATION FORM

What is a bidet?

Bidets are a fixture or system that uses a stream of water to cleanse you after using the bathroom.

What are the benefits of bidets?

- May increase independence and confidence
- Can improve dignity and privacy
- Maintenance of hygiene after toileting
- May reduce need for family or carers to help with toileting

TYPES OF BIDETS

Bidet/douche toilet seats:

Bidet toilet seats are placed on top of a toilet and replace the toilet seat and cover. These can come with features like removable lids, warm water, adjustable and self-cleaning nozzles, feminine and rear wash, heated seating, and air-drying functions. Must be installed by a certified plumber and may require the installation and annual check of a backflow prevention device.



Handheld bidet:

A handheld bidet is a flexible hose installed next to the toilet. These are often much cheaper than bidet toilet seats but require good range of movement to use effectively. Requires the installation and annual check of a backflow prevention device by a certified plumber.



Standalone bidette:

Standalone bidettes are separate to the toilet. They rely on the user being able to squat or sit over the bidet to use it, which requires good balance and strength.



MAINTENANCE AND UPKEEP

By law, any backflow prevention valves installed with must be tested and serviced **every year** by a certified plumber.

Some bidet/douche toilet seats will need a water filter. Water filters need to be replaced by a certified plumber. It is important to speak to the supplier or manufacturer you purchased your bidet from, to find out the best way to clean and service your bidet.

WARRANTY

Product warranty:

Most warranties on bidets cover breaks or problems that are the fault of the manufacturer or supplier e.g. the product is cracked on delivery or the product breaks within the warranty period at no fault of the user etc.

Please be aware that any **misuse** of the bidet might not be covered by warranty.

Installation warranty:

For plumbing work that is over \$750, a 6-year warranty usually applies if there are any problems with the installation within this period. A certified plumber should provide you with a certificate of compliance for this.

- By law, certified plumbers and electricians **MUST** install your bidet for any kind of warranty to be valid. Do not install this yourself.
- Some suppliers and installers might offer longer warranties for repairs of damages that occur at the fault of the user.

CONTACT DETAILS (optional)

Occupational Therapist Contact	Ph:
Name:	Email:
Supplier/Manufacturer Contact:	Ph:
Name:	Email:
Tradesperson Contact	Ph:
Name:	Email: